

Miele

Operating instructions

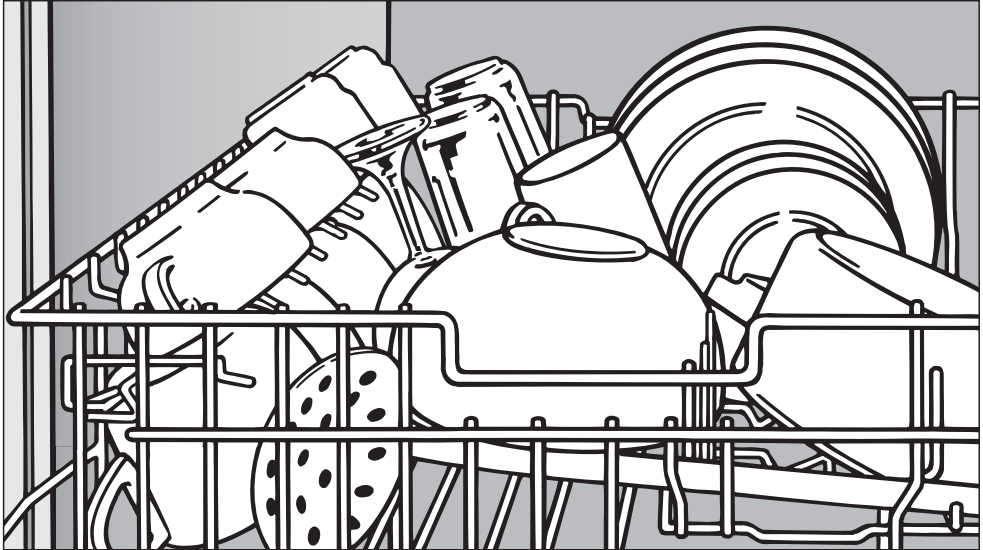

LaPerla G 2830 SCi

To prevent accidents
and machine damage
read these instructions
before
installation or use.

HG03



M.-Nr. 06 696 130

Contents

IMPORTANT SAFETY INSTRUCTIONS	4
Guide to the dishwasher	7
Control panel	8
Display	9
Caring for the environment	10
Before using for the first time	11
To open the door	11
To close the door	11
Child Safety Lock	11
Water softener	14
Filling the salt container	15
Salt refill message	16
Rinse aid	17
Adding rinse aid	17
Rinse aid refill message	18
Loading the dishwasher	19
Items not recommended for dishwashing	20
Cutlery tray	21
Upper basket	22
Adjusting the upper basket	26
Lower basket	27
Basket accessories	29
Use	30
Adding detergent	31
Turning on	32
Selecting a program	32
Program guide	33
Use	35
Selecting Options	35
Starting a program	36
Time display	36
At the end of a program	37
Interrupting a program	37
Changing a program	38

Additional options	39
Delay start	39
Settings 	41
Frequently asked questions	53
Technical faults	53
Problems water intake/drain	54
General problems with the dishwasher	56
Sounds	58
Poor cleaning results	59
After sales service	62
Transport	63
User Maintenance Instructions	65
Cleaning and Care	66
Triple filter system	67
Cleaning the spray arms	69
Cleaning the water inlet filter	70
Cleaning the drain pump and non-return valve	71
Installation instructions	73
Help to protect the environment	74
Electrical connection	75
Plumbing	76
Connection to the water supply	76
Drainage	77

IMPORTANT SAFETY INSTRUCTIONS

WARNING –

When using your dishwasher, follow basic precautions, including the following:

Read all instructions before installation or use of the dishwasher to prevent injury and machine damage.

The manufacturer cannot be held responsible for damage or injury caused by improper use of this appliance.

Use the dishwasher only for its intended purpose. This appliance is intended for residential use only.

Keep these operating instructions in a safe place and pass them on to any future user.

Electrical Safety

■ Before installation, make sure that the voltage and frequency listed on the data plate correspond with the household electrical supply. This data must correspond to prevent injury and machine damage. Consult a qualified electrician if in doubt.

■ Before installation or service, disconnect the power supply to the work area by unplugging the unit, "tripping" the circuit breaker or removing the fuse.

■ Do not use an extension cord to connect this appliance to electricity. Extension cords do not guarantee the required safety of the appliance (e.g. danger of overheating).

■ Be certain your appliance is properly installed and grounded by a qualified technician. To guarantee the electrical safety of this appliance continuity must exist between the appliance and an effective grounding system. It is imperative that this basic safety requirement be met. If there is any doubt, have the electrical system of the house checked by a qualified electrician. The manufacturer cannot be held responsible for damages caused by the lack, or inadequacy, of an effective grounding system.

IMPORTANT SAFETY INSTRUCTIONS

Installation

■ The dishwasher must be installed and connected in compliance with the installation instructions.

■ Installation and repair work should be performed by a Miele authorized service technician. Work by unqualified persons could be dangerous and may void the warranty.

■ Do not install or use a damaged dishwasher. A damaged appliance is dangerous. Unplug the machine and call your Miele dealer or the Miele Technical Service Department.

■ Ensure that any plastic wrappings, bags, etc. are disposed of safely and kept out of the reach of children. Danger of suffocation!

■ This equipment is not designed for maritime use or for use in mobile installations such as recreational vehicles or aircraft. However, under certain conditions it may be possible for an installation in these applications. Please contact the nearest Miele dealer or the Miele Technical Service Department with specific requirements.

■ It is recommended that the dishwasher only be connected to the mains with the plug (no hard-wiring). The outlet must be accessible at all times after installation to disconnect the dishwasher.

■  WARNING - Fire hazard
Do not cover or crush the plug of the appliance. Ensure that the cabinet opening for the dishwasher provides ample space for the plug. Installing the dishwasher in a tight space may crimp the power cord or put pressure on the plug which could cause overheating.

■ This dishwasher should only be installed under a continuous counter top secured to adjacent cabinetry.

■ Do not install this dishwasher beneath a cooking surface, oven or any appliance that radiates heat. High temperatures from these units may damage the dishwasher.

■ When installing the dishwasher under a counter top and removing the toe-kick, a build-under toe-kick must be installed. Use the respective installation kit. Danger of injuries.

■ Do not cut the intake hose or submerge it in liquid. This hose contains electrical components that could cause injury or property damage if cut or submerged.

■ Only connect the dishwasher to the mains when all installation and plumbing work is complete.

IMPORTANT SAFETY INSTRUCTIONS

Use

■ To reduce the risk of injury, do not allow children to play in, on or near the dishwasher.

■ Only use the dishwasher if all panels are properly in place.

■ Do not tamper with the controls.

■ Do not damage, sit or stand on the door or baskets of the dishwasher. Close the door when not in use.

■ Under certain conditions, hydrogen gas may be produced in a hot water system that has not been used for two weeks or more. **HYDROGEN GAS IS EXPLOSIVE.** If the hot water system has not been used for such a period, turn on all hot water faucets and let water flow from each for several minutes before using the dishwasher. This will release any accumulated hydrogen gas. Do not smoke or use an open flame during this time.

■ Be sure that all items placed in the dishwasher are "dishwasher safe". For items not labeled, check the manufacturer's recommendations.

■ When loading tableware, place sharp items away from the door to prevent damage to the seal. Load sharp items pointing downwards to prevent injuries.

■ Only use detergents and rinse aids recommended for residential dishwashers. Keep all detergents and rinse aids out of the reach of children.

■ Do not inhale or swallow detergents. Dishwasher detergents contain irritant and corrosive ingredients. They can cause burning in the mouth and throat if swallowed, or inhibit breathing. Consult a doctor immediately if detergent has been swallowed or inhaled.

■ Do not drink water from the dishwasher! Harmful residues could be present.

■ Do not fill the rinse aid reservoir or salt container with detergent. It will destroy the rinse aid compartment and water softener.

■ If the power cord is damaged it must only be replaced by a Miele Service technician with a genuine Miele power cord.

Disposal of an appliance

■ If the appliance is removed from its installation site and will not be used, remove the doorlock to the wash cabinet to prevent children from locking themselves in the machine.

SAVE THESE INSTRUCTIONS

Guide to the dishwasher

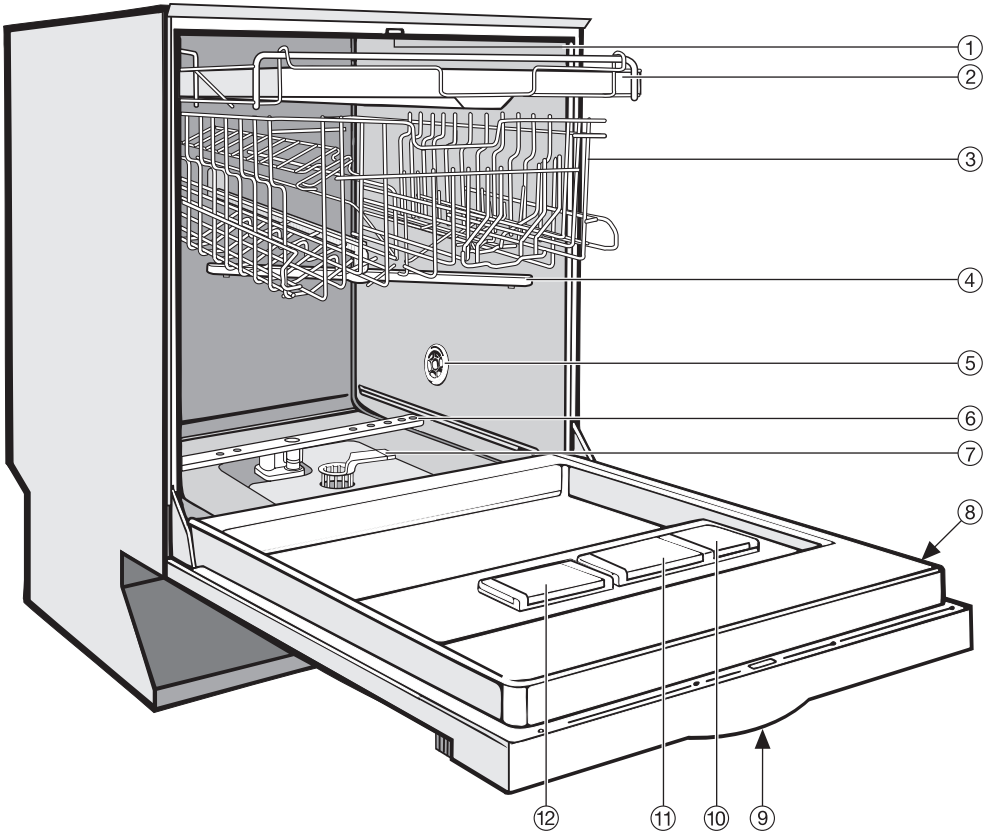

- ① Upper spray arm (not visible)
- ② Cutlery tray (depending on model)
- ③ Upper basket
- ④ Middle spray arm
- ⑤ Air inlet for drying (depending on model)
- ⑥ Lower spray arm
- ⑦ Filter combination
- ⑧ Data plate
- ⑨ Child Safety Lock in the door handle (not visible)
- ⑩ Rinse aid reservoir
- ⑪ Dual compartment detergent dispenser
- ⑫ Salt container

Guide to the dishwasher

Control panel

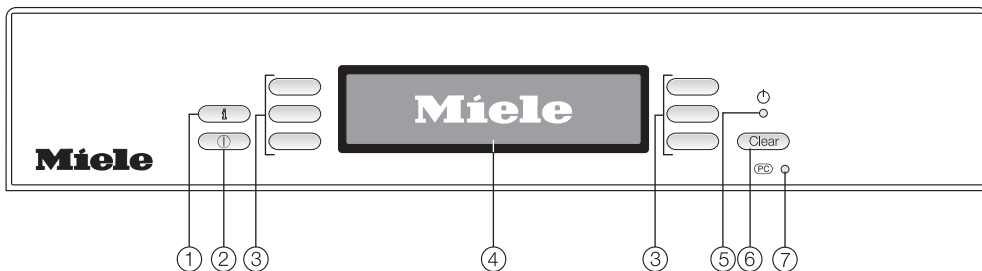

① **i (Information) touch control**

To display more info about the displayed menu

② **⏻ (On/Off) touch control**

To turn the dishwasher on and off

③ **Selection touch controls**

To select a menu point displayed next to the touch control.
To change the displayed value (+/-).
To browse between menus.

④ **Display**

See the following pages for more information

⑤ **Standby indicator**

The indicator lights when the dishwasher is turned on but the display is turned off.

⑥ **◀ C (Clear) touch control**

To switch back to the previous menu level or to delete a selected setting.

⑦ **Technical Service interface**

Allows a service technician to check and update the machine when applicable.

Display



The following can be selected in the display:

- the wash program
- the options
- the start time
- the settings  menu

During a running program the display shows:

- the program name
- the current time of day
- the program sequence
- the approximate remaining time
- faults and messages

A bullet in the display next to the touch control shows that a function can be selected with this control.

The arrow on the right side in the display shows that more selections or text follow and can be displayed with the respective control.

To confirm these messages or settings touch **OK** and the next menu or another menu level will appear.

The "Settings " menu allows you to adjust the dishwasher to your individual needs. See "Settings" for more information.

Caring for the environment

Energy saving washing

This dishwasher is exceptionally economical in the use of water and electricity. For best results follow these tips:

- For lowest energy consumption and the gentlest washing of china and crystal, connect the dishwasher to a cold water source.
- For fastest possible wash times, yet higher energy consumption, connect the dishwasher to a hot water source.
- If the dishwasher is connected to hot water, select "Energy Saver" when washing light to normally soiled dishware. The water will not be heated, therefore the dishes may be more wet at the end of this program than when using other programs.
- Make full use of the baskets without overloading for the most economical washing.
- Use the correct amount of detergent and rinse aid.
- When using powder or gel detergent reduce the amount to $\frac{2}{3}$ when washing a small load.
- Choose a program that best suits the degree of soiling and the type of dishes being washed.
- For small loads select "Short".

Before using for the first time

To open the door

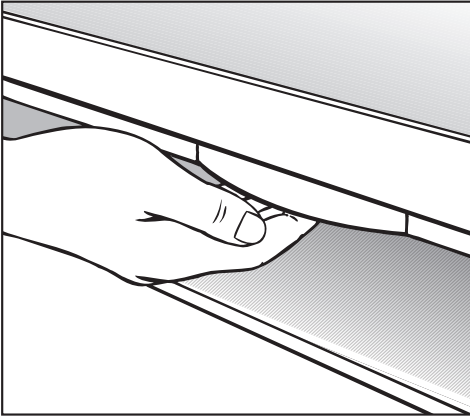

- Press the release catch inside the door grip.

If the door is opened during operation, the dishwasher will stop running. Once the door is closed the program will restart.

To close the door

- Push the baskets in.
- Lift the door and push until it clicks into place.

Child Safety Lock

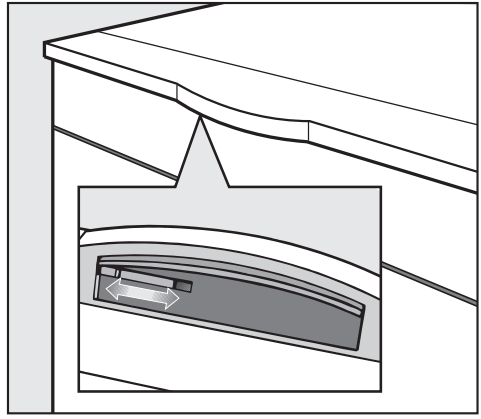

The Child Safety Lock is designed to prevent children from opening the dishwasher.

- To lock the door, push the slider below the door grip to the right.
- To unlock the door, push the slider to the left.

Before using for the first time

Welcome screen

- Turn the dishwasher on with the sensor ①.

The Welcome screen shows when the washer is turned on for the first time.

Language setting

The display changes automatically to the language setting.

The selected language is marked with a ✓ check.



- Select the desired language and confirm with "OK".

Time of day setting

The display changes automatically to the time of day setting.

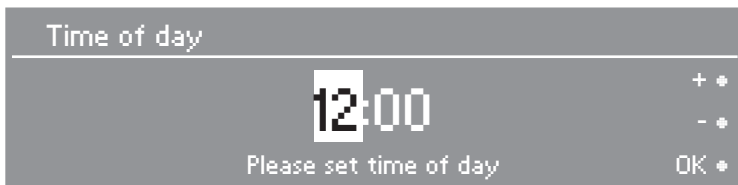

- Set the hours using the +/- controls and confirm with **OK**.
Set the minutes and confirm.

The settings will be saved after the first wash program has finished.

Before using for the first time

After confirming the minutes, a message shows confirming that the set-up of your machine has been successfully completed.

After confirming this message, the two messages **Insufficient salt** and **Insufficient rinse aid** may show. Confirm with **OK** and the display changes to the main menu.



The dishwasher can now be used or turned off.

Before using for the first time

Water softener

Every dishwasher is tested before leaving the factory. Any water remaining in the machine is from the final factory test and does not indicate that the machine has been used.

To achieve good cleaning results, the dishwasher needs soft water. Hard water results in calcium deposits on dishware and in the dishwasher. If your tap water hardness is above 4°d (8 gr/gal [140 ppm]), the water should be softened. This takes place automatically in the unit's integrated water softener.

The water softener sets automatically to the local water hardness.

If the hardness of your local supply is constantly lower than 4°d (8 gr/gal [140 ppm]), you do **not need to add water softener salt**.

The "Insufficient salt" message will turn off automatically.

For best results use salt when using 3 in 1 tabs (these tabs contain detergent, rinse aid and water softener salt). When selecting the "3 in 1" detergent setting, the salt dosage is reduced to $\frac{1}{3}$ to $\frac{1}{4}$.

Checking the water hardness

The water hardness measured by the sensor can be displayed. See "Settings  - Water hardness".

Before using for the first time

Filling the salt container

⚠ Inadvertently filling the salt container with dishwashing detergent will damage the water softener.

⚠ Only use water softener salt specially formulated for dishwashers. Other salts may contain insoluble additives which can impair the water softener.

When opening the salt container, water will run out. Open the container only to refill salt.

Important: The salt container must be filled with 2 quarts (2 l) of water **before adding salt for the first time**. Water does not have to be added with subsequent refills.

- To fill the salt, open the door and hold it at an angle, so that the salt container can be completely filled.

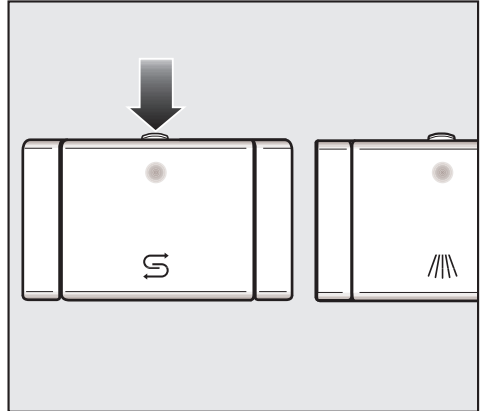

- Press the button in the direction of the arrow until the flap springs open.

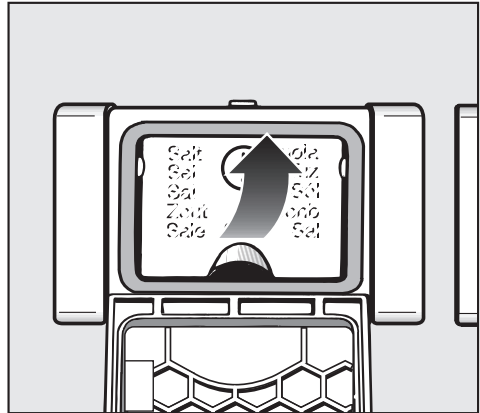

- Open the funnel.

Before using for the first time

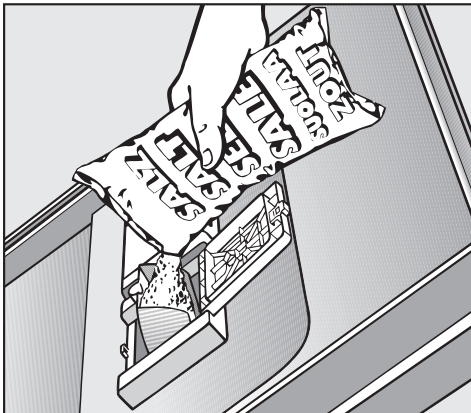

- Carefully fill with salt until water runs out. The salt container holds approx. 2.2 lbs (1 kg) of salt.

Do not fill with more than 2.2 lb (1 kg) salt.

As it is filled, water will run out.

- Clean any excess salt from the threads of the container opening. Close the lid firmly.
- If the dishwasher will not be used immediately, run the "Short" program. This will remove any traces of salt from inside the wash cabinet.

Salt refill message

- When the display shows **Insufficient salt**, refill the salt after the program has finished.
- Confirm with **OK**.

The message will clear from the display.

After the container has been filled, the water softener is automatically reactivated the next time the dishwasher is started. The **Insufficient salt** message will show again during this process. Confirm again with **OK**.

Before using for the first time

Rinse aid

Rinse aid helps to prevent spotting on dishes and glassware. The rinse aid is filled in the reservoir and the set amount will be automatically dosed.

 Filling the rinse aid reservoir with detergent will damage the reservoir. Only pour rinse aid formulated for residential dishwashers into the reservoir.

When using "2 in 1" or "3 in 1" detergents rinse aid is not needed. "2 in 1" detergents contain detergent and rinse aid. "3 in 1" detergents contain detergent, rinse aid and water softener salt.

Adding rinse aid

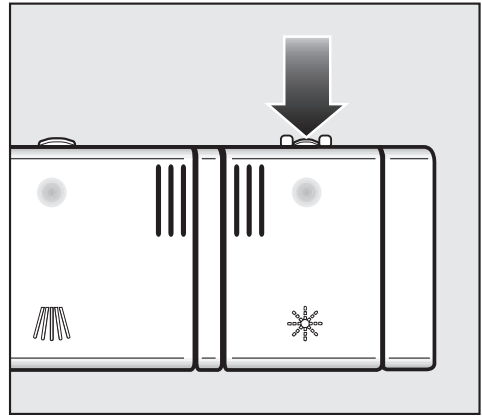

- Press the button in the direction of the arrow until the flap springs open.

Before using for the first time

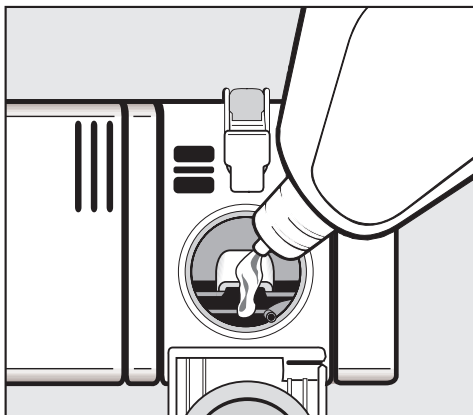

- Pour liquid rinse aid into the reservoir until it is visible on the surface of the screen.

The rinse aid reservoir holds approx. 3.7 oz (110 ml).

- Press on the flap until you hear it click shut. Failure to close it all the way allows water to enter the reservoir during the wash program.
- Clean any spilled rinse aid. The flap will remain closed during normal operation.

To optimize the wash result, the rinse aid dosage can be adjusted. See "Settings  - Rinse aid".

Rinse aid refill message

When the **Insufficient rinse aid** message first comes on, there will be enough rinse aid left for 2 - 3 washes.

- Refill rinse aid after the program has finished.

If the "2 in 1" or "3 in 1" function is selected, the **Insufficient rinse aid** message will not come on. See "Settings  - Detergent".

- Confirm with **OK**.

The **Insufficient rinse aid** message will clear from the display.

Loading the dishwasher

 Do not wash items soiled with ash, sand, wax, grease or paint in the dishwasher.

Ash and sand do not dissolve and will be distributed throughout the inside of the dishwasher.

Wax, grease and paint will cause permanent discoloration and damage to the dishwasher.

- Scrape food from dishes before placing them in the dishwasher, rinsing is not necessary.
 - Some foods contain natural dyes, e.g. carrots or tomatoes. Plastic items may discolor permanently if they come in contact with food dyes.
 - All items can be placed anywhere in the baskets.
 - Load dishes so that water can reach all surfaces. Do not place dishes or cutlery inside other pieces.
 - Make sure that all items are securely positioned.
 - Hollow items such as cups and glasses should be placed upside down in the baskets.
 - To ensure good water coverage, tall, narrow and hollow items, i.e. vases or champagne glasses, should be placed in the center of the basket rather than in the corners.
 - Concave based items such as mugs or bowls, should be placed at an angle so that water does not pool.
- The spray arms must not be blocked by items that are too tall or hang through the baskets. Check clearance by manually rotating the spray arms.
 - Place very small items in the cutlery tray or basket so they do not fall to the bottom of the wash cabinet.
 - Food residue and spilled liquids should be cleaned from the sides of the dishwasher door. These are outside of the wash cabinet and are not cleaned by water from the spray arms.

Loading the dishwasher

Items not recommended for dishwashing

- Cutlery with wooden handles
- Wooden cutting boards
- Glued items such as old knives with handles glued together around the shank of the blade
- Handmade craft items, antique, metal trimmed or decorative glassware
- Plastic items that are not heat resistant
- Copper, brass, tin or aluminum
- Dishes with color painted over the glaze. These dishes may fade over time
- Fine glassware and crystal items should only be washed using the "China & Crystal" program (depending on model). Otherwise clouding or etching may occur after frequent washing.
- Cast iron pots and pans

Glassware:

- There are no standard guidelines for washing glassware, when in doubt wash by hand.
- When purchasing new dishes, glasses and cutlery, make sure they are dishwasher safe. Only wash items marked "dishwasher safe" in the dishwasher.
- If fine glassware is washed in the dishwasher select the "China & Crystal" program. This will reduce the risk of clouding.

Silver and aluminum:

- Silver or aluminum items may tarnish.
- Silverware previously cleaned with a silver polish may be damp or spotted at the end of a program where water has adhered to the polish. This can be rubbed off with a soft, dry cloth. Silver that has been cleaned in an immersion dip is usually dry at the end of a program, but may tarnish.
- If left to dry, foods containing sulfur can discolor silver. These include egg yolk, onions, mayonnaise, mustard, fish and marinades.
- Silverware may tarnish or pit if washed next to stainless steel. Leave space between these metals.
- Clean aluminum items, e.g. grease filters, with domestic dishwasher detergent only.

Split cutlery tray

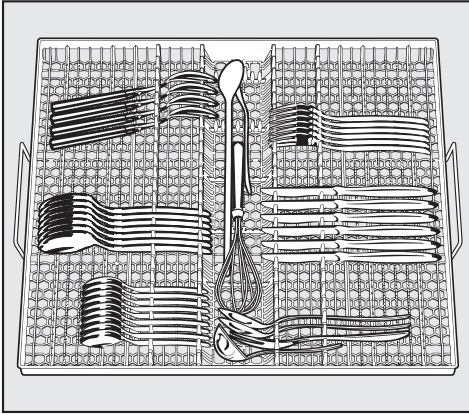

- Arrange the cutlery as shown in the cutlery tray.

For easier unloading cutlery should be grouped in zones, one for knives, one for forks, one for spoons, etc.

Place knives with the cutting edge and forks with the prongs between the holders. Spoons should be placed in the opposite direction with the handles between the holders.

The upper spray arm must not be blocked by tall cutlery items.

The inserts of the cutlery tray can be removed.

Single inserts can be removed to make room for tall items in the upper basket.

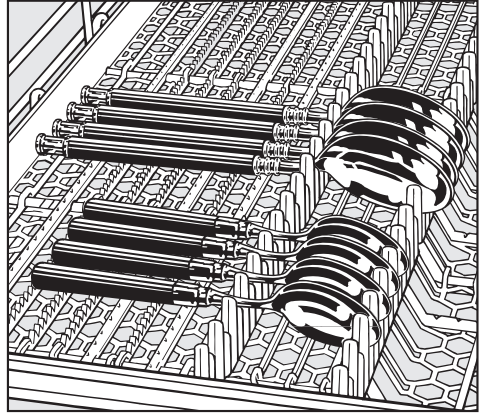

Spoons with thick handles may have to be placed as knives and forks with their heads in the holders

Loading the dishwasher

Upper basket

 For safety reasons only use the dishwasher with the upper and lower basket inserted.

Exception: The programs "Large items normal" and "Large items soiled" are designed for use without the upper basket.

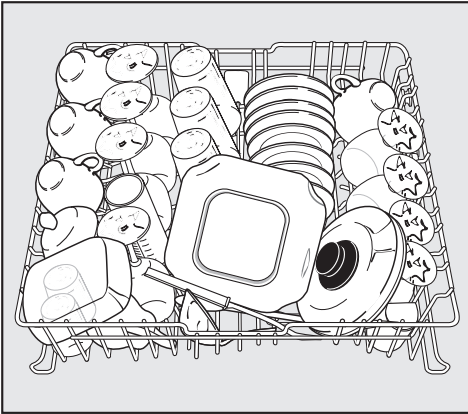

- Load the upper basket with small, lightweight, or delicate items such as cups, saucers, glasses, dessert bowls and flat pans.
- Long items such as soup ladles, mixing spoons and long knives should be placed lying down across the front of the upper basket.

Removable spike insert

The spike insert can be removed to create more space for larger items, e.g. a saucepan.

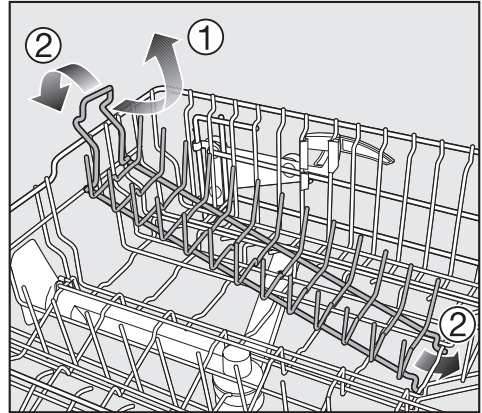

Removing an insert ①:

- To remove an insert, gently pull on the handle.

Inserting an insert ②:

- Slide the hitches of the insert under the vertical struts of the lower basket.
- Push down on the handle to snap the insert into position.

Loading the dishwasher

Adjustable cup racks

- Raise the rack to make room for tall glasses. Lower it to double stack smaller pieces.

The height of the cup rack can be adjusted in two levels.

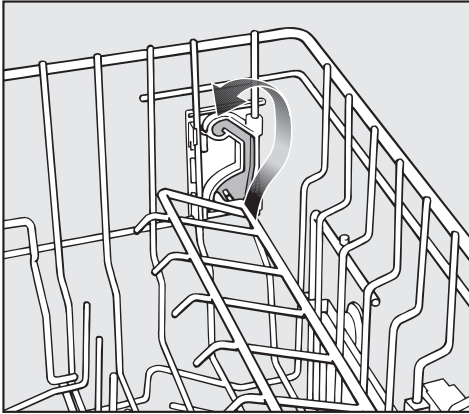

- Pull the cup rack upwards and let it engage at the desired height.

Coffee bar

(depending on model)

Glasses can be leaned against the coffee bar for a secure stand.

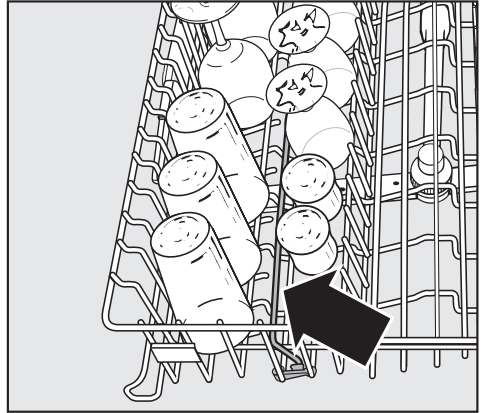

- The bar can also be used to separate two rows of glasses.
- To stack wide items, flip the bar to the right.

Loading the dishwasher

Glassware rail

(depending on model)

The glassware rail is designed for a secure stand of tall glasses and stemmed glassware.

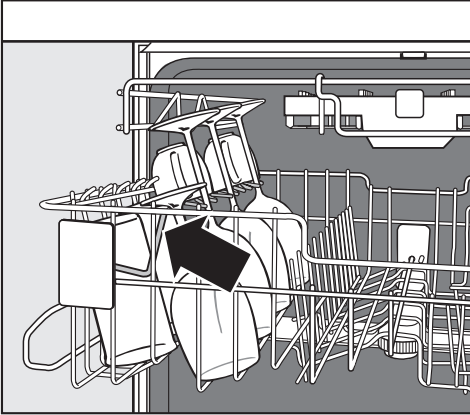

- Flip the bar down to lean tall glasses on it.
- If necessary take out part of the cutlery tray to make room for tall glasses.

Multi-function basket

The multi-function basket is designed to securely wash baby bottles, saucers and small items, e.g. toys.

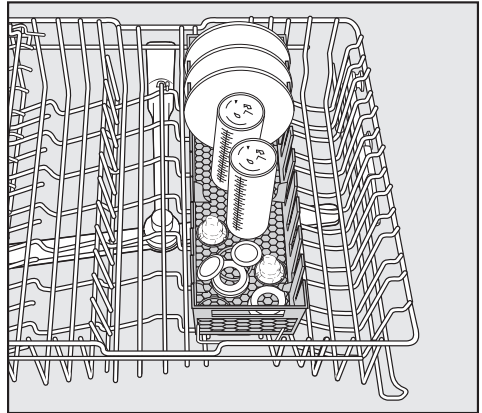

- Remove the spike insert on the right side of the upper basket and insert the multi-function basket.
- Close the flaps in the bottom of the basket when washing saucers or other small items.

To wash baby bottles

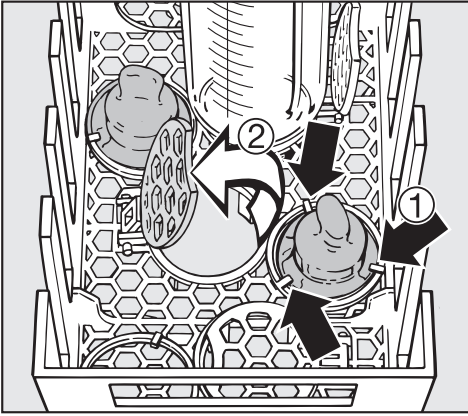

- Insert the nipples under the hooks ①.
- Open the flaps ② and insert the bottle neck into the opening.
- Small items like the rings and caps of the bottles can be inserted in the open spaces.

Loading the dishwasher

Adjusting the upper basket

The upper basket can be raised or lowered to accommodate tall items.

The basket can also be angled to fit tall items in both, the upper and lower baskets. The angles should not be set to opposite extremes. This will block the middle spray arm. Take care when sliding the basket in and out in this position.

- Slide out the upper basket.

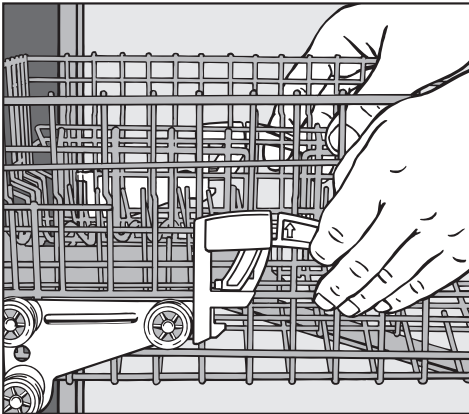

- Pull up the levers at the sides of the upper basket and adjust the basket height.
- Release the levers and the basket will lock in place.

Depending on the setting of the upper basket, a variety of plate dimensions can be accommodated.

For example: If the upper basket is in its highest position a plate with a diameter of $12 \frac{3}{16}$ " (31 cm) can be fit in the lower basket.

Lower basket

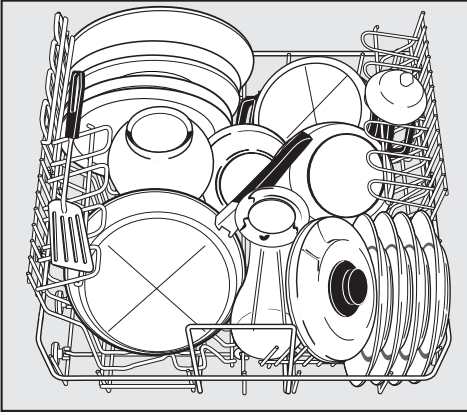

- For larger and heavier items such as plates, serving platters, saucepans, bowls, etc.

Loading the dishwasher

Comfort inserts

The comfort inserts are designed for cups, glasses, plates, bowls, pots, etc.

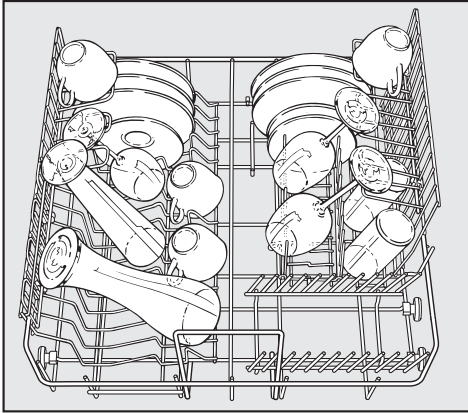

- To insert tall items, raise the cup rest.
- Lean or hang stemmed glassware such as wine or champagne glasses in the cut outs of the cup rest.

PlateGuard Plus with StemGuard

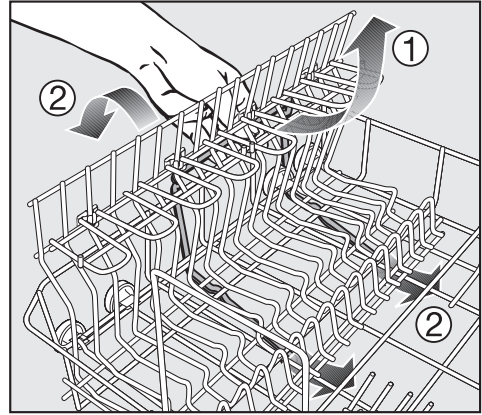

Removing an insert ①:

- To remove an insert, gently pull up on the handle.

Inserting an insert ②:

- Insert the long comfort insert on the left and the short one in the rear right.
- Slide the hitches of the insert under the vertical struts of the lower basket.
- Push down on the handle to snap the insert into position.

Loading the dishwasher

Removable spike insert with StemGuard

Removing:

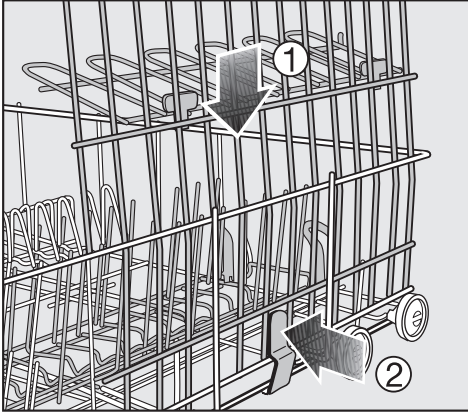

- Push the insert down, ① and at the same time push the latch towards the basket, ②.

Vase/Bottle holder

The vase/bottle holder, e.g. for vases and baby bottles, can be inserted into the lower basket as shown in the illustration.

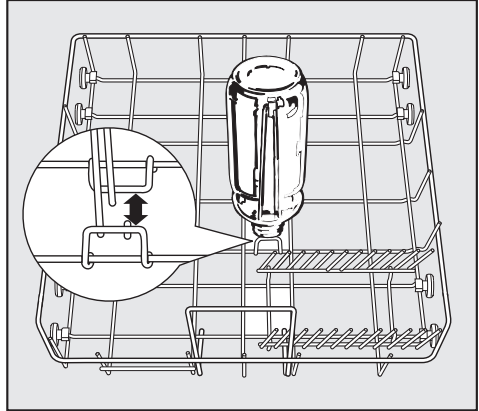

If placed anywhere else, water will not reach all surfaces. The bottle will not be properly cleaned.

Basket accessories

Additional inserts for the upper and lower baskets may be purchased from your Miele dealer or Miele.

Use

Detergent

 Dishwasher detergents contain irritant and corrosive ingredients. Avoid inhaling or swallowing dishwasher detergent. Keep children away from detergent. Fill the detergent dispenser only when you are ready to start the dishwasher.

 Only use detergents formulated for domestic dishwashers.

Use only the recommended amount of detergent. Continued use of too much detergent may cause machine damage.

You can use powder, gel or tab detergents. Follow the dosage information on the detergent packaging. See "Settings - Detergent" for more information on detergent usage.

Detergent tabs are not recommended for use with the program "Short". The tabs may not dissolve completely.

Adding detergent

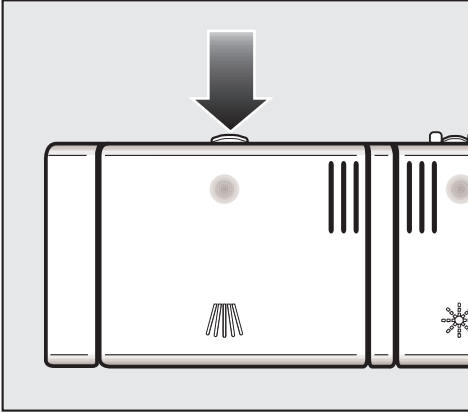

- To open, press the latch on the detergent dispenser. The flap will spring open.

The flap is always open at the end of a program.

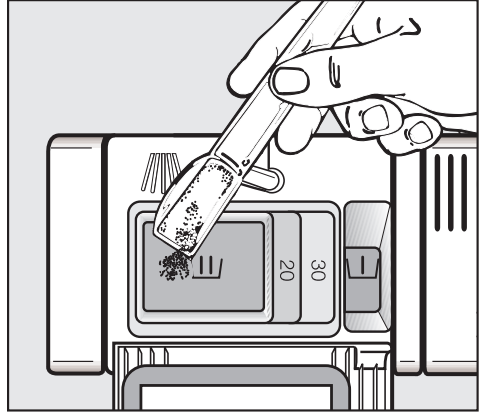

- Add detergent to compartment II and close the flap.
- If a Pre-rinse is desired, and available for your chosen program, add 1 teaspoon (5 ml) of detergent to compartment I.

The horizontal marks in compartment II indicate the levels of approximately 1 ¼ and 2 tablespoons (20 and 30 ml) respectively. Compartment I holds a maximum of 2 teaspoons (10 ml).

Use

Turning on

- Make sure the spray arms can rotate freely.
- Close the door.
- Open the water supply, if closed.
- Turn the dishwasher on by touching the  control.

The main menu shows in the display.

If the memory function is selected, the last selected program is displayed. See "Settings  - Memory".

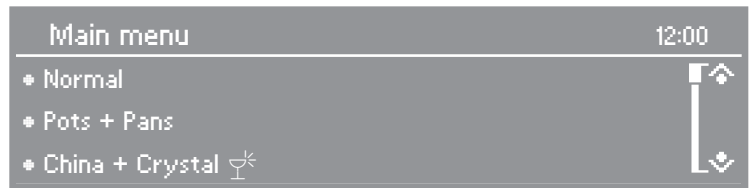

Selecting a program

Choose your program according to the type of load and soiling.

See the "Program guide" for a description of the programs and uses.

Information about the selected program can be displayed by touching the  control.

- Select the desired program.

The display changes to the program menu.



Program guide

Program	When to use	Program sequence				
		Pre-rinse 1 2	Main wash	Interim rinse 1 2	Final rinse	Drying
Normal	For normally soiled dishware with dried on food	X X	X	X	X	X
Pots + Pans	For normally soiled pots and pans with dried on food , and heavily soiled dishware, 120% detergent recommended	X	X	X	X	X
China + Crystal	For temperature sensitive glassware and lightly soiled dishware, 50% detergent recommended; sensor controlled GlassCare program	as required	X	X as required	X	X
Short	"Quick program" for lightly soiled dishware, e.g. party dishware or to remove salt traces from the wash cabinet after refilling salt, includes sensor controlled GlassCare; not suitable for detergent tabs		X	X	X	
Sensor Wash	Sensor controlled program for normally soiled dishware	as required	X	X as required	X	X
Economy	For normally soiled dishware, energy saving program with a long soaking time and a low temperature; includes sensor controlled GlassCare		X	X	X	X
Heavy Soil	For heavily soiled dishware with dried starchy food	X	X	X	X	X
Energy Saver	The water intake temperature must be a minimum of 115°F (45°C); for light to normally soiled dishware	X X	X	X	X	X
Rinse + Hold	To rinse dishes when a complete program is not needed.	X				
Water Saver	For light to normally soiled dishware without dried food; water saving program		X	X	X	X

Usage:

Electric: 0.01 - 1.3 kWh

Water: 1.06 - 6.6 gal (4 - 25 l)

Program guide

Program	When to use	Program sequence				
		Pre-rinse	Main wash	Interim rinse 1 2	Final rinse	Drying
Starch	For dishware with dried on starchy food ; 120% detergent recommended	X	X	X	X	X
Cheese	For dishware with dried on cheese ; 120% detergent recommended	X	X	X	X	X
Sani Wash	To sanitize dishware , e.g. baby bottles, cutting boards and preparation dishware		X	X X	X	X
Plastics	To gently clean dishwasher safe plastics and plastic toys	X	X	X	X	X
Large items soiled	For extra large, heat-resistant items e.g. large vases	X	X	X	X	X
Large items normal	For extra large items sensitive to high temperatures e.g. large plastics	X	X	X	X	X
Glassware no rinse aid	To wash glassware without detergent and rinse aid; rinse cycle with warm water		X	X	X	
Glassware cold	For a quick cleaning of glassware for direct reuse; use without detergent and rinse aid		X	X	X	
Plate Warming	For plate warming; use without detergent and rinse aid	X				

Usage:

Electric: 0.01 - 1.3 kWh

Water: 1.06 - 6.6 gal (4 - 25 l)

Selecting Options

Options can be added to the selected program.

■ Select **Options**.

The display shows the available options for the selected program.

Available options:

Pre-rinse:

- For easily removable soiling

Soak:

- To soak stubborn soiling.
When using powder detergent, fill approx. 1 teaspoon (5 g) of detergent in the detergent compartment I.

Extended drying:

- To enhance drying of odd shaped dishware and plastic items.



■ Select the desired options.

The selected options are marked by a ✓ check.

- To deselect the selected options, touch the respective control again.

■ When finished customizing the program, confirm with **OK**.

The display changes back to the program menu.

The program menu shows **Options selected**.

Use

You can now select the detergent used. Available selections are: Powder, Gel, "2 in 1" and "3 in 1" tabs.
See "Settings , Detergent".

Starting a program

- Select **Start**.

The program begins.

Cancel a program only in the first 5 minutes. Otherwise important program steps (e.g. the water softening) could be interrupted.

The program can be locked. To use this function, see "Settings  - Program lock".

Time display

Before the program starts, the time display shows the running time of the selected program in hours and minutes. During the running program the remaining time shows in the time display.

The running time for the same program may vary depending on the intake water temperature, the load size and soiling.

When a program is selected for the first time, a time is shown which equals an average program running time with cold water.

The time values in the program guide correspond to the program running times with standard loads and standard temperatures.

Each time a program is run, the electronic adjusts the program running time according to the water intake temperature and the load size.

At the end of a program

At the end of a program the display shows **Program finished**.

Dishes tends to chip if removed still hot from the dishwasher.

Let the dishware cool.

After turning off the dishwasher open the door slightly. The dishes will cool much faster.

- Open the dishwasher and unload the dishes.
- Turn the dishwasher off by touching the Ⓛ control.

The dishwasher continues to use electricity until turned off with the Ⓛ control.

- If the dishwasher is not used for a longer period of time, e.g. vacationing, turn off the water supply.

Interrupting a program

A program is interrupted as soon as the door is opened. If the door is closed, the program will continue from where it was interrupted.

 Open the door with care. The water in the dishwasher is hot. Danger of scalding. Before closing the door again, leave it ajar for approx. 20 secs. This will enable the temperature in the wash cabinet to settle. Close the door firmly until it clicks into place.

Use

Changing a program

If the detergent flap is already open, do not change the program.

If a program has already started and you wish to change it:

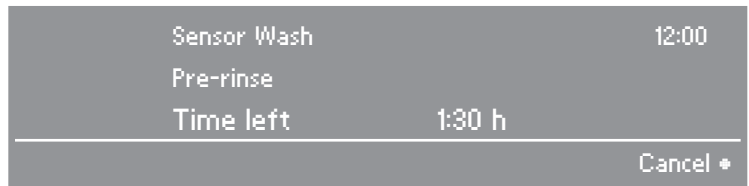

- Select **Cancel**.
- Confirm the message **Cancel program?** with **OK**.

The program is canceled.

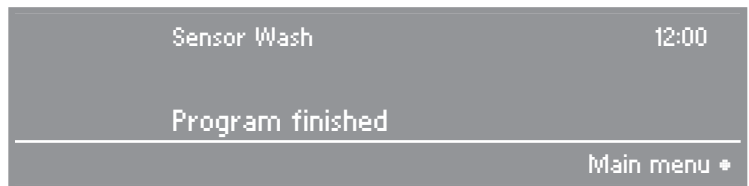

- Select **Main menu**.
- The display changes to the main menu.
- Select and start the desired program.

Delay start

The start time of a program can be delayed from 15 minutes to 24 hours in 15-minute-increments.

When using the "Delay Start" function, make sure that the detergent compartment is dry before adding detergent. Wipe dry with a cloth if necessary. Otherwise the detergent could stick together and not completely rinse out.

Liquid detergent should not be used when selecting "Delay Start", the detergent could leak.

 It is recommended to add the detergent and lock the dishwasher door to prevent children from coming in contact with the detergent.

- Turn the dishwasher on by touching the  control.
- Select the desired program.
- Select **Start time**.

The most recent saved start time will be displayed.

Sensor Wash	1:32 h	12:00
• Options		+ •
• Start time	12:00	- •
End at	1:32	OK •

- Select the desired start time with the **+/-** sensors. Holding the touch control automatically increases or decreases the time.

The end time is automatically adjusted.

- Confirm with **OK**.
- Select **Start**.

Additional options

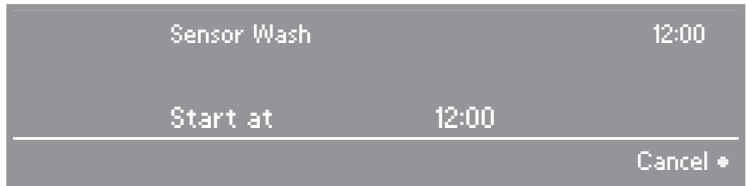

The program name and the start time are displayed.

The program starts automatically at the selected time.

Starting a program before the delay start has elapsed:

A program can be started before the delay start time has elapsed. Proceed as follows:

- Select **Cancel** and confirm with **OK**.
- Select **Main menu**.

The display changes to the main menu.

- A program can now be selected and started.

The "Settings

Open the Settings

- Turn the dishwasher on by touching the  control.

The main menu shows in the display.

If the memory function is selected, the last selected program is displayed. See "Settings  - Memory". In this case, switch to the main menu by touching  C (Clear).



- Select Settings .

The display changes into the menu "Settings .



- Select the desired setting.

The selected options in the submenus are marked with a check .



Settings

Language

The display contents can be shown in different languages.

The displayed language can be changed by the submenu "Language ".

- Select the desired language and confirm with **OK**.

The flag behind the word "Language " serves as a guide when an unfamiliar language is selected. Select the respective menu with a flag until the submenu **Language ** appears.

Time of day

The selection allows the clock to be shown as 24 or 12 hours and to set the clock.

Setting the clock format

- Select **Format**.
- Select the desired clock format and confirm with **OK**.

Set the time of day

- Select **Set manually**.
- Set the hour with **+/-** and confirm with **OK**. Set the minutes and confirm.

The display changes back into the "Time of day" menu.

- Touch **◀ C** to get back into the "Settings " menu.

Detergent

To achieve the best results the used detergent can be set on your dishwasher. The selection allows "Powder", "Gel", "2 in 1" and "3 in 1" tabs. The program cycle sequence will be adjusted for the selected detergent. Depending on the program the program running time may increase.

Powder

When using powder detergent, salt and rinse aid must be added for best results. See "Filling the salt container" and "Rinse aid". The rinse aid refill message is activated.

Gel

When using gel detergent, salt and rinse aid should be added for best results. See "Filling the salt container" and "Rinse aid". The rinse aid refill message is activated.

2 in 1 tabs

The function "2 in 1" adjusts the program cycle to the use of "2 in 1" detergent products (detergent with rinse aid). The rinse aid dosage and the rinse aid refill message are deactivated.

3 in 1 tabs

The function "3 in 1" adjusts the program cycle to the use of "3 in 1" detergent products (detergent with rinse aid and water softener salt). The rinse aid dosage and rinse aid refill messages are deactivated. The salt usage for the water softener will be reduced to $\frac{1}{3}$ and $\frac{1}{4}$.

Do not use this extra feature

- when using "2 in 1" detergents (detergent with rinse aid).
- if your tap water has a water hardness of over 380 ppm (21gr/gal) [21°dH]). See also the information from the detergent manufacturer.

The cleaning and drying performance of these detergent products vary.

The detergent selection is set by default to powder detergent.

- Select the detergent used and confirm with **OK**.

Water hardness

The dishwasher is equipped with a sensor softener, which automatically detects the hardness of your tap water. After plumbing the dishwasher and finishing a program, e.g. "Rinse & Hold", the water hardness is displayed in the menu "Water hardness".

- Touch **OK** to go back to "Settings .

Rinse aid

For best results, the rinse aid dosage can be adjusted. The dosage can be set in steps from 0 to 6 ml.

The dosage set by default to 3 ml of rinse aid per program.

- Use a higher setting if spots appear on dry glassware.
- Use a lower setting if streaking appears on dishes or glasses.
- Select the desired rinse aid dosage with the **+/-** controls and confirm with **OK**.

Filter check

This selection allows you to set the number of cycles run before the filter check message shows. You can select between 30 and 60 cycles.

The filter check message is set by default to 40 cycles.

- Select the desired interval and confirm with **OK**.

Adjust Sensor Wash

The "Sensor Wash" program can be adjusted to clean stubborn but normal soiling.

- Select **Yes** to activate this function and confirm with **OK**.

Reorganize program list

The order of the programs in the program list can be reorganized. Frequently used programs can be saved to the first three positions.

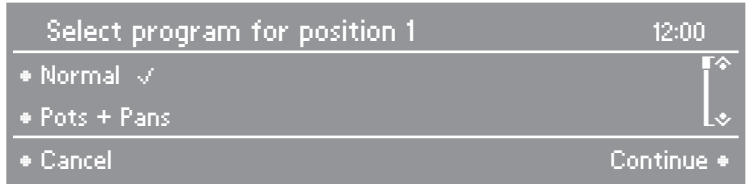

- Select the program to be saved to the first program list position.
- Confirm with **Continue**.
- Repeat for the program to be saved to the second and third program list position.

The selected programs are now shown.

To change a program position, select **Back** until you reach the respective program position.



- When finished reorganizing the program list, confirm with **Finished**.

Settings

Save options

Additional options can be selected for some programs, e.g. extended drying. See "Use - Selecting options".

Save options allows you to save the selected options for future use with this program.

The function is turned off by default.

- Select the desired setting and confirm with **OK**.

Child Safety Lock

The Child Safety Lock protects the dishwasher from misuse.

If the dishwasher is turned on while the Child Safety Lock is activated, the display shows **The appliance is locked**.

The lock must be deactivated before the dishwasher can be used.

As long as the Child Safety Lock is activated, the dishwasher is locked every time it is turned on.

The function is turned off by default.

- Select **On** to activate this function and confirm with **OK**.

Canceling the Child Safety Lock

Unlocking the dishwasher

- Turn the dishwasher on by touching the  control.

The message **The appliance is locked** shows.

- Confirm with **OK**.



- Select the option **Yes**.

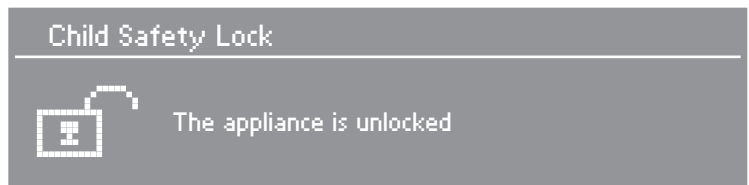

The dishwasher is unlocked and ready to use.

Program lock

The running program can be locked. This function prevents accidentally changing a program during use.

You can select if the program lock should be activated or not. The actual locking of the program is done when a program is started.

The function is turned off by default.

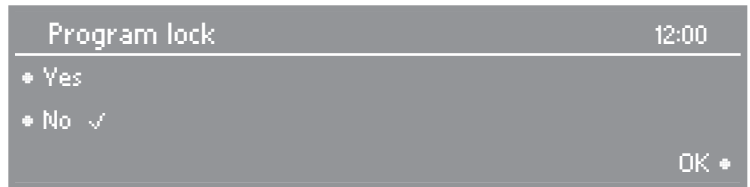



- Select **Yes** to activate this function and confirm with **OK**.
- Touch **◀ C** to go back to the main menu.

Locking a program

To lock a program, a program must be started first.

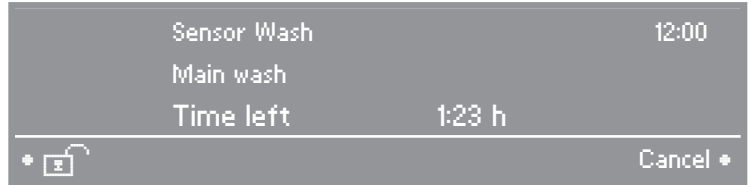
- Select a program and begin it with **Start**.



- Select .
- Select **On** to activate this function and confirm with **OK**.

The program is locked. It stays locked until the lock is deactivated.

To cancel a running program, the program lock must be deactivated first.

Once the program is finished, deactivate the lock or turn the dishwasher off and on again before starting a new program or selecting settings.

Deactivating the program lock

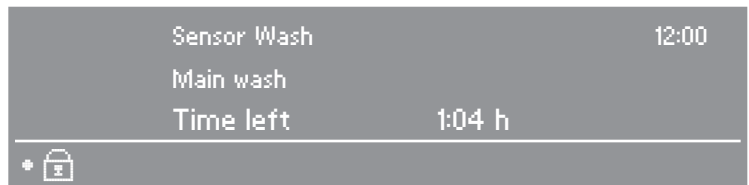

- Select  and confirm with **OK**.
- Select **Off** to deactivate this function and confirm with **OK**.

The program is unlocked. Any selections can be made.

Settings

Temperature

The temperature can be displayed in °C/Celsius or °F/Fahrenheit.

The temperatures are shown in °C/Celsius by default.

- Select the desired temperature unit and confirm with **OK**.

Buzzer

When the buzzer is activated, a tone sounds at the end of a program and if a fault occurs.

The buzzer at the end of a program is turned off by default.

Buzzer at the end of a program

The buzzer at the end of a program sounds five times in intervals with a brief break. The buzzer sounds up to one hour if the dishwasher is not turned off.

Buzzer in case of a fault

The buzzer for a fault sounds continuously. The buzzer sounds up to two minutes if the dishwasher is not turned off or the fault is fixed.

The buzzer for a fault cannot be turned off.

Buzzer volume

Two buzzer volumes can be selected or the buzzer can be deselected.

Off

The buzzer tone at the end of a program is turned off.

Soft

The tone sounds in a soft volume.

Loud

The tone sounds in a loud volume.

- Select the desired volume or deactivate the buzzer.
- Confirm with **OK**.

Keypad tone

A tone will sound when a control is touched.

The keypad tone is turned on by default.

- Select the desired option and confirm with **OK**.

Brightness

The display brightness can be adjusted in 17 levels.

The brightness is set to level 8 by default.

- Select the desired brightness and confirm with **OK**.

Contrast

The display contrast can be adjusted in 17 levels.

The contrast is set to level 8 by default.

- Select the desired contrast and confirm with **OK**.

Standby

To save energy the display is turned off 10 minutes after a control is touched.

The standby indicator flashes.

To turn the display on again, touch any control.

The function is turned off during a running program by default.

- Select the desired option and confirm with **OK**.

Memory

The memory function saves the last selected program.

If you turn the dishwasher off and on again or open and close the door after a program has finished, the display shows not the main menu but the last selected program.

The function is turned on by default.

- Select the desired option and confirm with **OK**.

Dealer

Demo modes are only for showrooms.

The dishwasher has three demo programs for showrooms.

The programs "Demo mode" and "Endless demo mode" show the use and function range of the dishwasher.

- **Demo mode:**
The program is started by touching a control. It runs once and must be started again.
- **Endless demo mode:**
The program starts after it was activated and runs in a loop until it is turned off.
- **Demo wash sound:**
The program activates the pumps to demonstrate the wash sound.

Turning the demo mode on

- Select the desired option and confirm with **OK**.
- Confirm the message **Activate demo mode?** with **OK**.
- Touch any control to start the selected demo mode.
- To cancel the demo mode, touch any control again and confirm with **OK**.

Turning the demo mode off



- Select **Off** to deactivate the demo mode and confirm with **OK**.
- Confirm the message **Deactivate demo mode?** with **OK**.

Factory default

All settings can be reset to factory default.

- Confirm the message **Reset to factory default?** with **OK**.
- Confirm the information **All settings are reset to factory default** with **OK**.

Leaving the "Settings menu"

To leave the "Settings  touch the  C control. The main menu shows.

Frequently asked questions

With the aid of the following guide, minor problems can be fixed without a service call.

 Repairs should only be carried out by a qualified and trained person in accordance with local and national safety regulations. Unauthorized repairs could cause personal injury or machine damage.

Technical faults		
Issue	Possible fault	Solution
After the dishwasher was turned on the display stays off and the stand by indicator does not flash.	The machine is not plugged in.	Insert the plug.
	The fuse has tripped.	Reset the circuit breaker. Make sure it is a 15 A breaker.
The dishwasher stops during a program.	The fuse has tripped.	Reset the circuit breaker. Make sure it is a 15 A breaker.
The buzzer sounds. The display shows the following: Technical fault FXX Call Technical Service	There may be a technical fault.	<ul style="list-style-type: none"> – Turn the dishwasher off by touching the Ⓢ control. After a few seconds: <ul style="list-style-type: none"> – Turn the dishwasher on. – Select the desired program. – Select Start. If the problem persists, call Technical Service.
The buzzer sounds. The display shows the following: Fault Waterproof F70	The waterproof system has activated.	<ul style="list-style-type: none"> – Turn off the water supply. – Call Miele Technical Service.



Frequently asked questions

Problems water intake/drain		
Issue	Possible fault	Solution
The buzzer sounds. The display shows the following:		
No water intake Open the water faucet	The water supply is closed.	Open the water supply all the way.
Fault water intake FXX		Before fixing the fault: <ul style="list-style-type: none"> – Turn the dishwasher off by touching the Ⓢ control.
	Fault F12/F13: Fault in the water intake.	<ul style="list-style-type: none"> – Open the water supply all the way and restart the program. – Clean the water intake filter, see "User Maintenance Instructions". – The water pressure at the water connection is lower than 4.35 psi. Consult a plumber.

Frequently asked questions

Issue	Possible fault	Solution
<p>The program "Energy Saver" displays the fault: Water intake temp. too low</p>	<p>The intake water does not have a minimum temperature of 115°F (45°C). See "Plumbing - Connection to the water supply".</p>	<ul style="list-style-type: none"> – Restart the program. – If the fault is displayed again, use a different program.
<p>The buzzer sounds. The display shows the following: Drain fault FXX</p>	<p>Fault F11: Fault in the water drain. There might be water in the wash cabinet.</p>	<p>Before fixing the fault:</p> <ul style="list-style-type: none"> – Turn the dishwasher off ①. – Clean the triple filter. – Clean the drain pump and the non-return valve. – Clean the drain pump and the non-return valve. <p>See "User Maintenance Instructions" for instructions on the above.</p> <ul style="list-style-type: none"> – Remove any kinks in the drain hose.

Frequently asked questions

General problems with the dishwasher		
Issue	Possible fault	Solution
The display remains off.	The display has gone into "Standby" mode to save energy.	Touch any control. See "Settings  - Standby" for more info.
The buzzer sounds during a running program. The display shows the following: Salt container lid Close the salt container lid	The salt container lid was not closed properly.	<ul style="list-style-type: none"> – Close the salt container lid If the salt container lid opened during a running program, also: <ul style="list-style-type: none"> – Turn the dishwasher off and on again with the  control. – Restart the program.
The display shows the following: Middle spray arm blocked or Lower spray arm blocked	<p>The middle or lower spray arm is blocked by dishware.</p> <p>The spray arm jets of the middle or lower spray arm are clogged.</p>	<p>Open the dishwasher door and rearrange the items blocking the spray arms.</p> <ul style="list-style-type: none"> – Turn the dishwasher off by touching the  control. <p>Then:</p> <ul style="list-style-type: none"> – Clean the spray arms. See "User Maintenance Instructions".



Frequently asked questions

Issue	Possible fault	Solution
Detergent is left in the dispenser at the end of a program.	The dispenser was damp when detergent was added.	Dry the dispenser before adding detergent.
The detergent lid cannot be closed properly.	Detergent residue is blocking the catch.	Remove the residue.
The door and the interior walls are still wet after a program has finished.	This is not a fault. It is the normal operating mode of the drying system.	The moisture will evaporate after a short time.
Water remains in the wash cabinet at the end of a program.		Before fixing the fault: – Turn the dishwasher off by touching the ① control.
	The triple filter in the wash cabinet is clogged.	Clean the triple filter. See "User Maintenance Instructions".
	The drain pump or the non-return valve may be blocked.	Clean the drain pump and the non-return valve, see maintenance instructions.
	The drain hose is kinked.	Remove any kinks from the drain hose.



Frequently asked questions

Sounds		
Issue	Possible fault	Solution
There is a knocking noise in the wash cabinet.	The spray arm is hitting an item in the basket.	Interrupt the program, rearrange the items blocking the spray arm.
There is a rattling noise in the wash cabinet.	Items are not secure in the wash cabinet.	Interrupt the program and rearrange loose items.
There is a knocking noise in the water pipes.	This may be caused by the installation or the diameter of the pipe.	This has no effect on the dishwasher. If in doubt contact a plumber.

Frequently asked questions

Poor cleaning results		
Issue	Possible fault	Solution
The dishes are not clean.	The dishes were not loaded correctly.	See "Loading the dishwasher".
	The program was not powerful enough.	Select a more intensive program, see "Program Guide".
	Stubborn but normal soiling (e.g. tea).	Use the function "Adjust Sensor Wash". See "Settings  - Adjust Sensor Wash".
	Not enough detergent was dispensed.	Use more detergent, see "Adding detergent".
	The spray arms are blocked by items.	Turn the spray arm and rearrange the dishes if necessary.
	The triple filter is clogged or not correctly inserted. The spray arm jets may be clogged.	Clean the filter and insert it correctly, see "User Maintenance Instructions".
	The drain pump or the non-return valve is blocked. Wash water will run back into the wash cabinet.	Clean the drain pump and the non-return valve. See "User Maintenance Instructions".
There are smears on glasses and cutlery, bluish sheen on the surface of glasses and a film that can be wiped off.	The rinse aid dosage is set too high.	Reduce the dosage. See "Settings  - Rinse aid".

Frequently asked questions

Issue	Possible fault	Solution
Dishes are not dry, glasses and cutlery are spotted?	The rinse aid setting may be too low or the rinse aid reservoir is empty.	Increase the dosage, refill the reservoir or switch the rinse aid product when refilling, see "Before using for the first time".
	Dishes were taken out too soon.	Leave dishes in longer, see "Use".
	"2 in 1" or "3 in 1" products were used. These products have a low drying effect.	Set the detergent type to "Powder" and insert rinse aid. See "Settings  - Detergent".
	The detergent "2 in 1" or "3 in 1" is set, but another product was used.	Select the detergent setting to the detergent used. See "Settings  - Detergent".
White residue is visible on cutlery and dishes, clouding occurs on glassware and film can be wiped off.	Not enough rinse aid was used.	Increase the dosage. See "Settings  - Rinse aid".
	The salt container is empty.	Refill salt, see "Before using for the first time".
	Unsuitable "2 in 1" or "3 in 1" products were used.	Use a different detergent. Try normal tabs or powder detergent.
	The automatic water softener unit is defective.	Call Miele Technical Service.

Frequently asked questions

Issue	Possible fault	Solution
Glasses are discolored and the film cannot be wiped off.	Detergent deposits.	Use a different detergent.
Glasses are dull and discolored and film cannot be wiped off.	Glasses are not dishwasher safe.	There is no remedy. Only wash dishwasher safe glasses in the dishwasher.
Tea or lipstick stains have not been completely removed.	The wash temperature of the selected program was too low.	Select a program with a higher temperature.
	The detergent has a low bleaching effect.	Use a different detergent.
Plastics are discolored.	Natural dyes e.g. from vegetables may be the cause. Not enough detergent was used to break down natural dyes.	Use more detergent, see "Adding detergent". Discoloration is permanent.
There are rust stains on cutlery.	The affected items are not corrosion resistant.	There is no remedy. Only wash dishwasher safe cutlery in the dishwasher.
	No program was run after refilling salt. Salt residuals got in the wash cycle.	Start the "Short" program without a load after refilling salt.

After sales service

Repairs

In the event of a fault which you cannot correct yourself please contact the Miele Service Department at the phone number on the back of this booklet.

- Please quote the model type and number of your appliance.

These can be found on the data plate along the right edge of the door.

PC Update

The Program Correction (PC) allows a technician to update the dishwasher to make use of new technology.

When, for example, technological developments offer advanced modifications to your existing program cycles a service technician will be able to input these into your machine controls via the indicator light marked PC. Miele will provide information when such possibilities become available.

MieleCare

MieleCare, our Extended Service Contract program, gives you the assurance of knowing that your appliance investment is covered by 5 years of worry free ownership.

MieleCare is the only Extended Service Contract in the industry that guarantees repairs by a Miele Authorized Service Provider using genuine Miele parts. Only genuine Miele parts installed by factory trained professionals can guarantee the safety, reliability, and longevity of your Miele appliance.

Please note that unless expressly approved in writing by Miele's Service department, Extended Service Contracts offered by other providers for Miele products will not be recognized by Miele. Our goal is to prevent unauthorized (and untrained) service personnel from working on your Miele products, possibly doing further damage to them, you and/or your home.

To learn more about **MieleCare** Extended Service Contracts, please contact your appliance dealer or visit us online at:

www.store.miele.com

To transport the dishwasher, e.g. when moving to a new home, note the following:

- Empty the dishwasher.
- Secure any loose parts, e.g. hoses, cables, cutlery baskets.
- Transport the dishwasher in the upright position. If unavoidable it may be transported on its back. Do not transport it on its side or on the door. Residual water in the machine could leak and cause electrical damage.

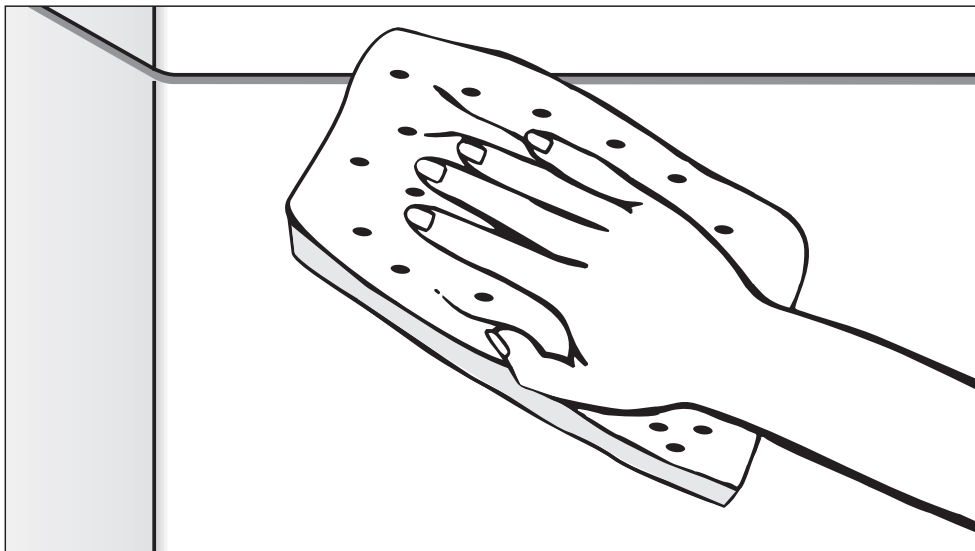

User Maintenance Instructions

To prevent accidents
and machine damage,
read these instructions
before installation or use.

Cleaning and Care

Check and clean your dishwasher regularly (approx. every 4-6 months). This will help avoid problems and faults.

 Abrasive cleaning agents, glass cleaning agents, all-purpose cleaners, thinner or ammonium cleaners should not be used on the dishwasher. They **will** damage the surface.

Wash cabinet

Generally, the wash cabinet is self cleaning if the correct amount of detergent is used.

The wash cabinet can be cleaned with a dishwasher cleaner such as "Dis Cleaner" available from your Miele dealer, Miele or online at www.store.miele.com.

Door and the door seal

- Wipe the door seals regularly with a damp cloth to remove food deposits.
- Food residue and spilled liquids should be wiped from the sides of the dishwasher door. These are outside of the wash cabinet and are not cleaned by water from the spray arms.

Exterior

- Only use a conditioner suitable for your kitchen cabinetry.
- Clean wood only with a damp cloth and wipe dry.
- Stainless steel surfaces can be cleaned using a non-abrasive stainless steel cleaner or with dishwashing detergent and warm water.
- To help prevent resoiling, a conditioner for stainless steel can also be used. Apply sparingly with even pressure.

Control panel

- Plastic control panel should only be wiped with a damp cloth or suitable cleaning agent designed for use on plastic.
- For stainless steel panels see information above.

 The stainless steel surfaces and controls may become discolored or damaged if not cleaned regularly. The appliance front and controls are not scratch proof. Remove spills immediately.

Triple filter system

The triple filter system in the base of the wash cabinet prevents food from being redeposited on dishes. It also protects the circulation pump from damage caused by foreign objects (e.g. broken glass, bones, etc.).

 The machine must not be used without all the filters in place!

Check and clean the filter system every 4-6 months or whenever a foreign object is trapped. The level of soiling and time it takes before the filters need cleaning will vary depending on household.

The display shows **Filter check** after 40 wash cycles (default setting).

The filter check frequency can be set from 30 to 60 cycles. See "Settings  - Filter check".

- Check and clean the triple filter.
- Confirm with **OK**.

The display changes to the program menu.

Cleaning the triple filter

- Turn off the dishwasher before cleaning.

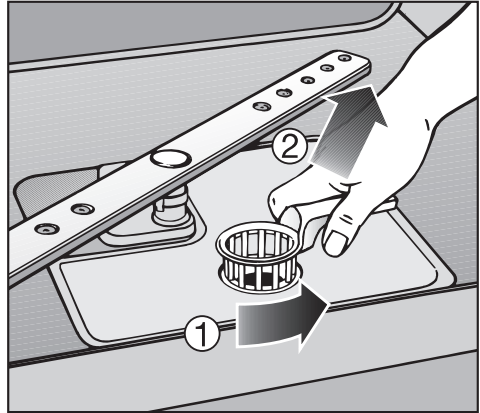

- Turn the handle counterclockwise to release the triple filter system, ①.
- Remove the triple filter from the machine. Clean any solid particles and rinse under running water. Scrub with a nylon brush if necessary.

Cleaning and Care

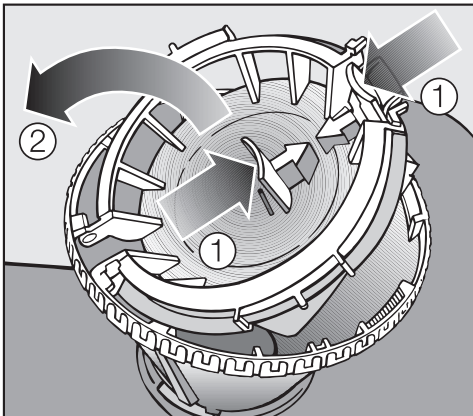

To clean the underside of the filter the flap must be opened.

- Push the clips together ① and open the flap ②.
- Rinse under running water.
- Close the flap so that the clip engages.

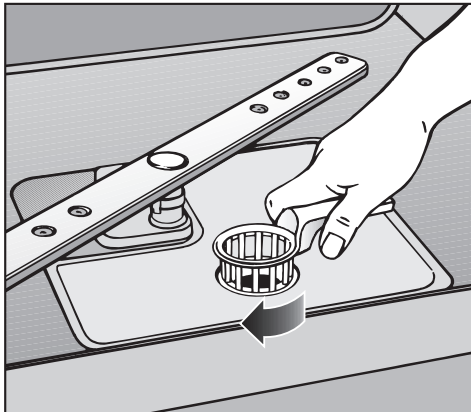

- Return the filter so it lies flat in the base of the wash cabinet.
- Lock the filter by turning the handle clockwise.

 The triple filter system must be inserted and locked. Large particles could get in the circulation system and cause blockage.

Cleaning the spray arms

Sometimes particles of food get stuck in the spray arm jets. The spray arms should be inspected and cleaned every 4 - 6 months.

- Turn off the dishwasher before cleaning.

Removing the spray arms

- Remove the cutlery tray (if present).
- Press the **top** spray arm up to engage the inner ratchet and unscrew the spray arm.

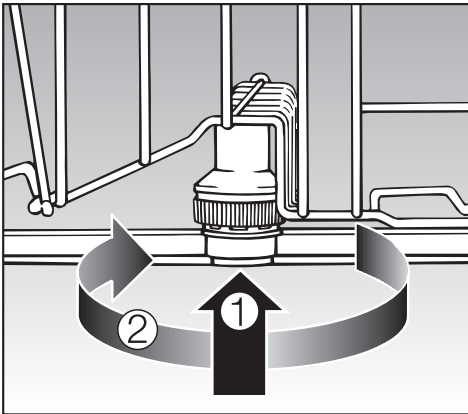

- Lift up the **middle** spray arm, ①, to engage the ratchet and unscrew the spray arm, ②.
- Remove the lower basket.

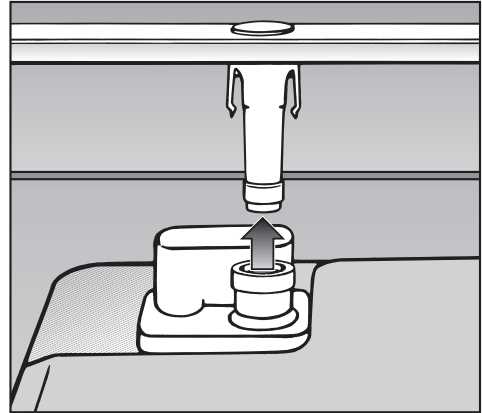

- Pull the **lower** spray arm firmly upwards to remove.

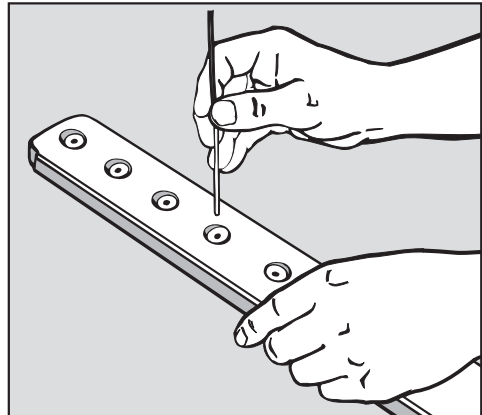

- Use a pointed object such as a toothpick to push food particles into the spray arm jets.
- Rinse thoroughly under running water.
- Return the spray arms and check that they rotate freely.

Cleaning and Care

Cleaning the water inlet filter

A filter is incorporated into the intake hose attached to the dishwasher's shut off valve. If your water is hard or the pipes contain sediment, this filter may clog and prevent enough water from entering the wash cabinet.

 The plastic housing of the water connection contains electrical wiring. Do not submerge the housing in liquid. Do not cut the intake hose or submerge it in liquid.

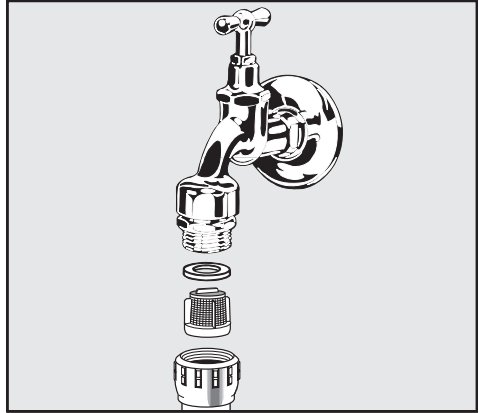

Installing an in-line water filter

If your water contains a large number of insoluble substances, a filter between the water valve and the intake hose connection is recommended. These filters can be purchased from Miele.

Cleaning the filter

- Turn off the dishwasher and pull the plug.
- Turn off the water supply.
- Unscrew the intake hose.

- Carefully remove the rubber seal.
- Remove the filter using needle nose pliers and rinse it under running water.
- Reinsert the filter and seal. Make sure they are seated correctly.
- Screw the intake hose back on the water valve, checking that it is not cross-threaded.
- Slowly turn on the water supply and test for leaks.

Cleaning the drain pump and non-return valve

If the dishwasher is not completely drained at the end of a program, the drain pump or non-return valve may be blocked.

- Turn off the dishwasher and pull the plug.
- Remove the triple filter (see "Triple filter system").
- Use a jug or bowl to scoop water out of the wash cabinet.

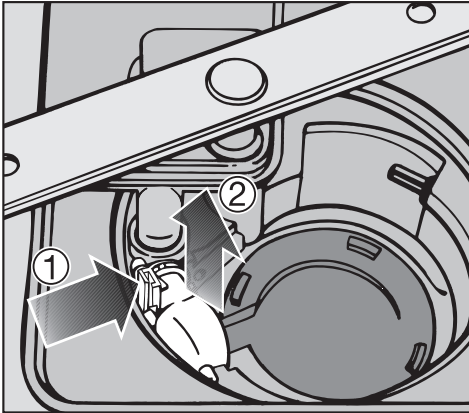

- Tilt the locking clamp to the side ①.
- Pull out the non-return valve ② and rinse it under running water.
- Remove all foreign objects from the non-return valve.

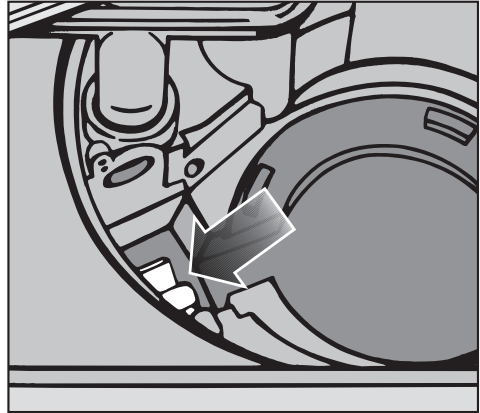

The drain pump is beneath the non-return valve (see arrow).

- Remove all foreign objects from the drain pump (glass or bone splinters).
- Before returning the non-return valve, check that the drain pump is not blocked. Spin the propeller several times in both directions to check for obstructions.
- Carefully reinsert the non-return valve and secure it with the locking clamp.

 Make sure the locking clamp clicks into place!

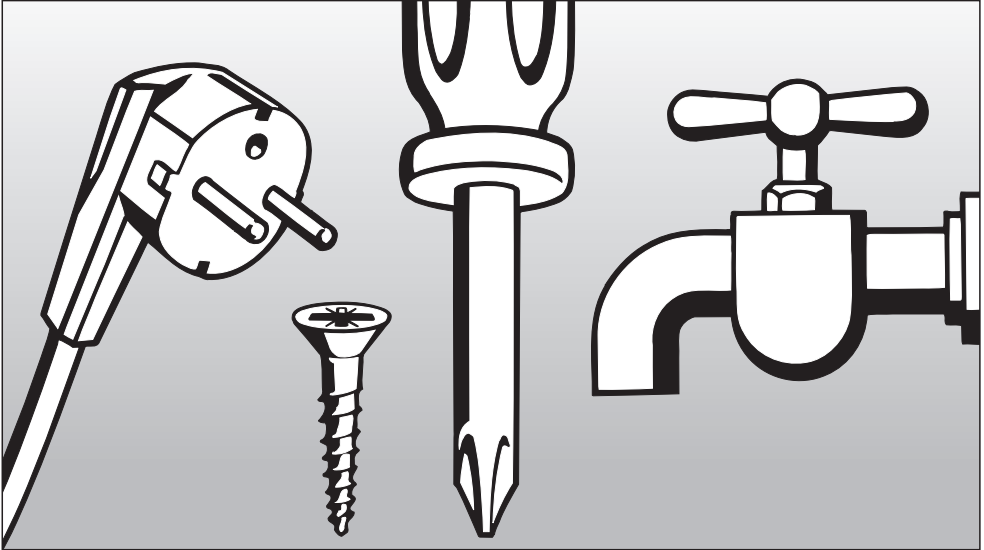

Installation Instructions

For installation of the dishwasher
please refer to the Installation Sheet
supplied with these instructions.

Help to protect the environment

Disposal of the packing material

The cardboard box and packaging protect the appliance during shipping. These materials are biodegradable and recyclable. Please recycle.

Ensure that any plastic wrappings, bags etc. are disposed of safely and kept out of the reach of children.
Danger of suffocation!

Disposal of an old machine

Old appliances may contain materials that can be recycled. Please contact your local recycling authority about the possibility of recycling these materials.

Ensure that the appliance presents no danger to children while being stored for disposal. Before discarding an old appliance, unplug it from the outlet, cut off its power cord and remove any doors to prevent hazards.

 Installation, repairs and other work by unqualified persons could be dangerous. The manufacturer cannot be held responsible for unauthorized work.

Check that the voltage, frequency and fuse rating shown on the data plate match the household mains supply.

The power outlet must be accessible after installation. Do not use an extension cord to connect the dishwasher to the mains. Danger of overheating! See data plate on the right side of the door.

A damaged power cord must only be replaced with a genuine Miele cord by a Miele service technician.

 **Improper connection of the equipment grounding conductor can result in electric shock. Do not modify the plug provided with the appliance; if it will not fit the outlet, have a proper outlet installed by a qualified electrician. If there is any question concerning the proper electrical connection or grounding of this appliance to the power supply, please consult a licensed electrician or call Miele's Technical Service Department:**

 1-800-999-1360

 1-800-565-6435

GROUNDING INSTRUCTIONS

THIS APPLIANCE MUST BE GROUNDED.

In the event of a malfunction or breakdown, grounding will reduce the risk of electric shock by providing a path of least resistance for the electrical current. This appliance is equipped with a cord having an equipment grounding conductor and a grounding plug. The plug must be plugged into an appropriate outlet that is installed and grounded in accordance with all local codes and ordinances.

Specifications

The dishwasher comes equipped with a 4 ft (1.2 m) power cord with a molded plug for connection to 120 V, 60 Hz, 15 A grounded receptacle.

Plumbing

Connection to the water supply

 Do not drink water from the dishwasher!

- The dishwasher can heat its own water to the temperature required by the wash program. This allows for connection of the machine to either a hot or cold water source. For lowest energy consumption connect the dishwasher to a cold water source. For fastest possible wash times, with slightly higher energy consumption, connect the dishwasher to a hot water source. All programs use hot water in the rinse cycles.
- To use the "Energy Saver" program, a hot water connection of minimum 115°F / 45°C and maximum 140°F / 60°C (water intake temperature) is necessary. The higher the water intake temperature, the better the cleaning and drying results.
- The inlet hose is approx. 5 ft. (1.5 m) long. A 5 ft (1.5 m) flexible metal hose (pressure resistant up to 2030 psi) is available.
- The water inlet hose comes equipped with a 3/4" female hose thread connector. This can be directly connected to a water supply with 3/4" MHT (male hose thread ends).
- Water pressure: Must be between 4.5 - 145 psi (0.3 - 10 bar). If the water pressure is lower, the display shows **Water intake** see "Frequently asked questions".

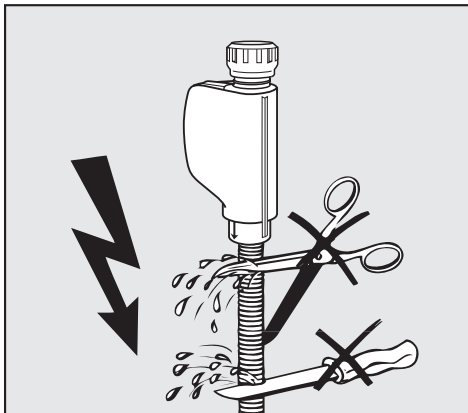

 Do not cut the intake hose. It contains electrical wiring. If the hose is cut, the dishwasher will not work. There will be a water leak and you could be injured. If the hose is too long, coil it neatly and place it behind the machine.

Drainage

- The machine comes equipped with a built-in non-return valve on the discharge side to prevent waste water from flowing back into the dishwasher.
- The dishwasher is equipped with a 5 ft (1.5 m) flexible drain hose with an internal diameter of 7/8" (22 mm).
- Drain hose extensions and adapters can be ordered from Miele. The maximum drain hose length is 13 ft. (4 m), max. drain height: 39" (1 m).
- If the hose is to be directly fitted to the drainage outlet on site, use the supplied hose clip.
- The hose can be installed to the left or right side.
- The existing drain pipe for the drain hose is designed for various hose diameters. The drain pipe must be shortened if the drain pipe extends too far into the drain hose. The drain hose could get clogged.
- The drain hose must not be shortened.
- Make sure the hose is installed without kinking, pressure or being pulled.

Venting the drainage system

If the dishwasher drain hose is connected to a floor drain or to a drain pipe that is less than 8" (20 cm) above the floor, the drain must be vented. Otherwise the water inside the dishwasher may siphon out during the wash program.

- Open the dishwasher door and remove the lower basket.
- Pull the lower spray arm firmly upwards to remove.

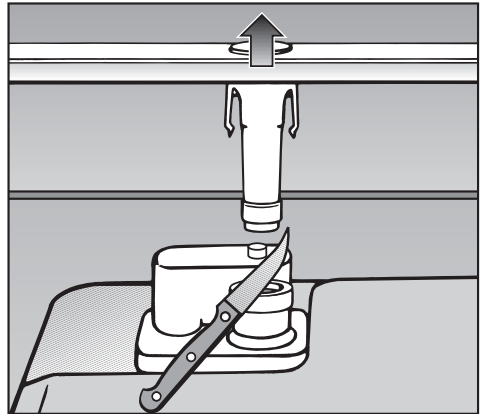

- Cut off the vent cap located at the right rear of the triple filter system, as illustrated.

When contacting the Technical Service,
please quote the model and serial number
of your appliance.



Miele, Inc. (USA)

National Headquarters

9 Independence Way
Princeton, NJ 08540
Phone: 800-843-7231
609-419-9898
Fax: 609-419-4298
www.miele.com

**Technical Service & Support
Nationwide**

Phone: 800-999-1360
Fax: 888-586-8056

Miele Limited (CDN)

National Headquarters

55G East Beaver Creek Road
Richmond Hill, ON L4B 1E5
Phone: 800-643-5381
905-707-1171
Fax: 905-707-0177
www.miele.ca
info@miele.ca (general enquiries)
professional@miele.ca (commercial enquiries)

Mielecare National Service

Phone: 800-565-6435
905-850-7456
Fax: 905-850-6651
service@miele.ca (Tech. Service)